

AXXAIR orbital cutting

A proper tube preparation is essential to produce a proper weld.

High quality cutting is guaranteed by AXXAIR's orbital cutting machines. The machines feature stainless steel concentric jaws to prevent the deformation of the tubes.

The perfect position of the tube within the machine also guaranty the perpendicularity of the cut as the saw travels around the tube and the consistency that perpendicularity cut after cut.

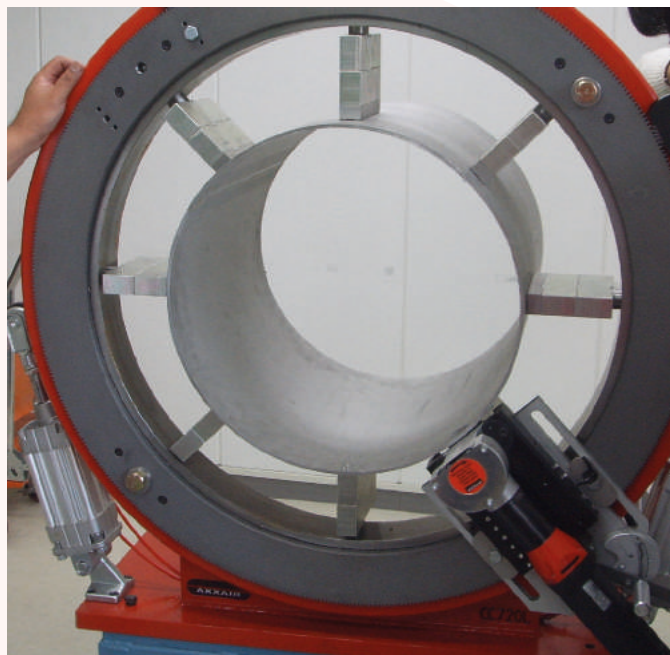

The precision of our cutting machine allow a perfect tube to tube alignment, with the smallest gap possible, removing the need to facing the tube therefore saving a significant amount of time and money.

AXXAIR's orbital cutting machines are an indispensable tool for any automatic and orbital welding.

AXXAIR has the **largest orbital cutting range in the world !**

11 different models to cut tubes from diameter **5 to 1100 mm!**

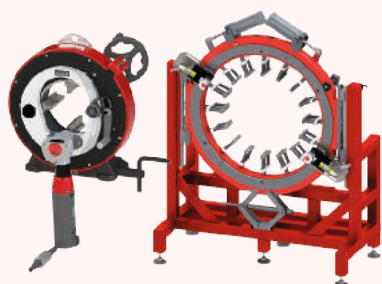

FLEXIBILITY, PRODUCTIVITY

AXXAIR frames are quickly and easily scalable for bevelling and orbital welding.

QUALITY

Cutting with no tube distortion, (multi-contact concentric clamping) ideal for thin walled stainless steel tubes. High quality geometric cutting (perpendicularity of <math><0.25\text{ mm}</math>) and excellent surface quality (few burrs).

PORTABILITY

With the easy to remove sawing attachment, AXXAIR's cutting machines are easy to transport on site or move within a workshop. Perfect preparation for thick tubes before bevelling and welding with wire.

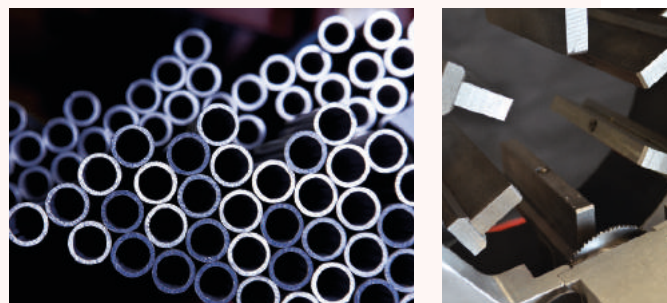
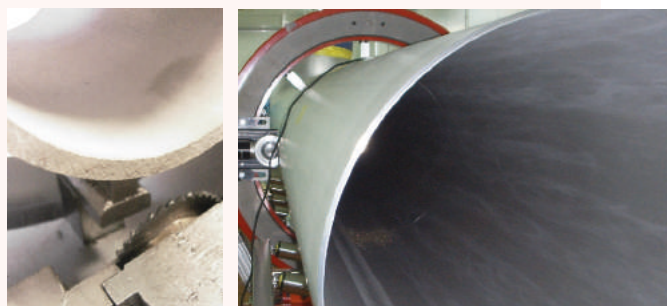

Please do not hesitate to contact us for all enquiries relating to orbital cutting technology.

We are glad to share our decades long experience in orbital cutting and helping you to select the solution that fits your needs.



122 - 172 - 222 - 322

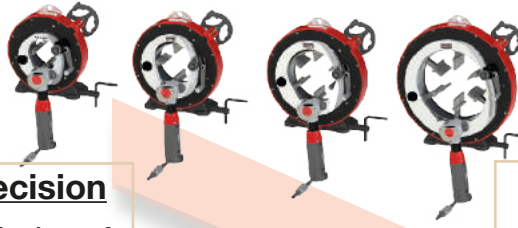

No tube deformation

Concentric clamping



Basic and extra stainless steel jaws: no pollution of stainless steel tubes

Cutting precision

Perpendicularity of < 0.25 mm

Cutting quality

Rotation handle for controlled and continuous cutting speed

A perfect sealing against chips

All rotating parts are incorporated in the body



Reduced vibration and increased blade life

Optimised blade to jaw distance

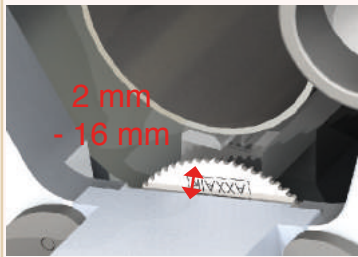

Global Process

Can be transformed into an orbital bevelling and welding machine

Uptake

feature a dual blade position allowing to cut elbows or flanges with no wasting of tube.

1200W motor or pneumatic motor (as required)

Cutting capacity: Up to 15 mm wall thickness*

Easy handling and transportation

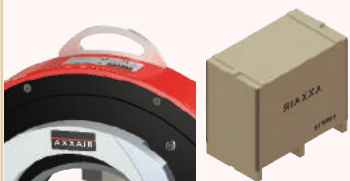

Continuous use

Anti-twist cable with bearings. Protects the electric cable from damage resulting from rotation around the tube.

Opening capacity

122	ø5 - ø119 mm 0.25" - 4.5 "
172	ø16 - ø173 mm 0.625" - 6.625 "
222	ø55 - ø228 mm 2.375" - 8.625 "
322	ø141 - ø328 mm 5.563" - 12.750 "

*depending on the type of steel



122- 172 - 222- 322

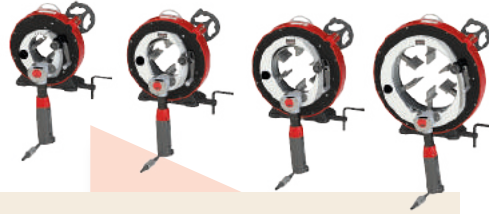

AXXAIR
INNOVATIVE ORBITAL SOLUTIONS

Technical specifications:

Low speed motor:

120V or 230V, 1200W, electronic speed variator with a cutting compensator

Vibration level in accordance with standard EN 28662: <math><2.5\text{m/s}^2</math>, Protection class: IP 20

Rotation speed (6 speed variations): from 30 RPM to 75 RPM

Pneumatic motor:

60 to 110 rpm, air flow 1500 l/min at 6 bar

All motors are supplied in their own individual cases, including the necessary tools



Robustness:

Very efficient clamping system thanks to a screw without end directly engaged on the clamping cam.

Easy maintenance and control:

- Lubrication of the inner parts with the grease nipples
- Quick access to the inner screw

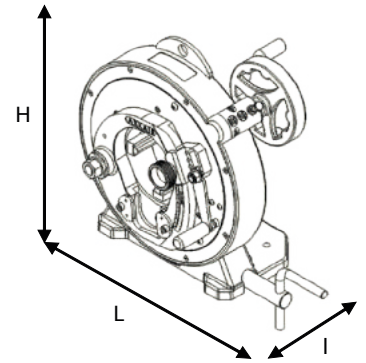
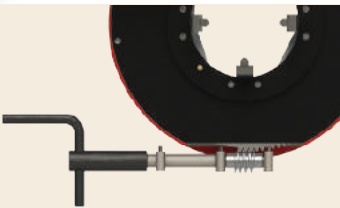

	Product Code	Machine's jaw opening capacity in mm		Net weight	Dimensions (HxLxW in mm)
		With basic jaws	With extra jaws (included)		
120V 1200W low-speed motor	122FS15	Ø29 - Ø119	Ø5 - Ø99	44 kg	443 x 541 x 304
	172FS15	Ø74 - Ø173	Ø16 - Ø116	51 kg	493 x 566 x 304
	222FS15	Ø128 - Ø228	Ø55 - Ø155	59 kg	548 x 594 x 304
	322FS15	Ø230 - Ø328	Ø141 - Ø239	71 kg	649 x 644 x 304
230V 1200W low-speed motor	122FS25	Ø29 - Ø119	Ø5 - Ø99	44 kg	443 x 541 x 304
	172FS25	Ø74 - Ø173	Ø16 - Ø116	51 kg	493 x 566 x 304
	222FS25	Ø128 - Ø228	Ø55 - Ø155	59 kg	548 x 594 x 304
	322FS25	Ø230 - Ø328	Ø141 - Ø239	71 kg	649 x 644 x 304
Pneu- matic motor	122PD	Ø29 - Ø119	Ø5 - Ø99	44 kg	443 x 541 x 304
	172PD	Ø74 - Ø173	Ø16 - Ø116	51 kg	493 x 566 x 304
	222PD	Ø128 - Ø228	Ø55 - Ø155	59 kg	548 x 594 x 304
	322PD	Ø230 - Ø328	Ø141 - Ø239	71 kg	649 x 644 x 304



Join experience

